

**Have you started planning for the future
or are you still stuck in the past?**



Europe's No. 1 for fingerprint access solutions.



More than 1 million satisfied customers are the best possible recommendation for our products! Both private households and leading companies, along with organizations such as fire and rescue services, have been putting their trust in the ekey fingerprint scanner for many years.

ekey was founded in 1999 and is now Europe's No. 1 for fingerprint access solutions. ekey puts authorization into the customer's hands! Keys, cards, codes, etc. can be lost, forgotten, or stolen. „Your finger is always on hand!“ ekey's wide range of products includes access solutions for doors, gates, alarm systems and time recording.

The international company currently has 70 employees at its 5 locations in Austria, Germany, Liechtenstein/Switzerland, Italy, and Slovenia and exports its products to over 70 countries, with exports making up 73% of its business. ekey's main sales markets include Spain and the USA, in addition to Austria, Germany, Switzerland, Slovenia, and Italy.

QUALITY

All ekey products undergo a rigorous endurance test before they reach the market. The test involves intensive simulations of blazing heat, biting cold, and high humidity; each fingerprint scanner, along with all of its components, is subjected to these conditions countless times before reaching the customer.

Our quality formula comprises the highest standards of functionality, reliability, and security, which are refined by means of extensive testing.

Quality-tested products from ekey – you can count on us!

CERTIFIED QUALITY MADE IN AUSTRIA:

- Extensive production, manufacturing, and functional testing (zero tolerance)
- Testing for environmental and temperature resistance
- Vibration- and shock-tested
- Tested for penetration of water and mechanical parts
- Quality management system in accordance with EN ISO 9001:2015
- CE-compliant



Good reasons for using an ekey fingerprint scanner

 **UNIQUE COMFORT**
You can't lock yourself out: your finger is always at hand!

 **HIGHEST SECURITY**

- No lost or stolen keys!
- Maximum protection against fake fingers thanks to live finger detection with RF sensor technology!
- Access rights (e. g. card or key) cannot be transferred!
- 1,000 more secure than a 4-digit code!

 **USER-FRIENDLY**
Easy installation and administration!

 **INTELLIGENT SOFTWARE**
The ekey software is learning all the time – it can detect the growth of children's fingers as well as minor injuries and changes to users' habits.

 **KNOW WHO IS COMING HOME**
By using the ekey fingerprint access control system, building control systems can now detect "which person" triggers an action.

 **5-YEAR QUALITY GUARANTEE**
for all ekey products!



Today, planning for the future starts right at your front door.

Design isn't the only defining feature of a state-of-the-art building – innovative technology is too. Already on its way to conquering the world of smartphones and tablets, fingerprint access is also setting its sights on access control for companies and households. Some might consider it the stuff of science fiction, but there are over a million satisfied customers actually using this technology day to day. Not only are ekey fingerprint scanners secure and convenient, but they also offer a whole range of benefits that transport your building into the realms of state-of-the-art innovation.

The benefits speak for themselves – and the reasons to choose this technology couldn't be clearer:

- 👍 Keyless access solutions are the future – a fact that people are already convinced of.
- 👍 State-of-the-art access solutions are a fundamental feature of advanced building concepts – and the first impression counts.
- 👍 ekey fingerprint access solutions are the most secure, most convenient way of entering a house.
- 👍 Fingerprint access solutions don't just appeal to younger groups of buyers – they offer the older generation a whole host of benefits too.
- 👍 Accessibility for young and old alike is often a key consideration for customers.
- 👍 Unique identification creates the ideal conditions for a home automation system that works as efficiently as possible – with ekey, your building is ideally equipped to face the future.

Plan buildings to be even **smarter and safer!** You literally hold the future in your hands.

PIQUED YOUR INTEREST? CONTACT US!

The ekey team will be delighted to advise you.

T: +43 732 890 500 - 2500 | E: office@ekey.net

ekey provides the right solution for every requirement.

The right access solution for my private space.

ekey home

Single-point access solutions

Control up to 3 functions with just one fingerprint scanner*.

- Can store up to 99 fingers
- Can be used to control from 1 to 3 functions (e.g. door, gate and alarm system)
- Easy to operate with central user administration directly via the control panel
- Or by using the ekey home app (ekey finger scanner integra, ekey finger scanner arte)
- Optional: Transponder access (RFID) is possible -> can also store up to 99 transponders

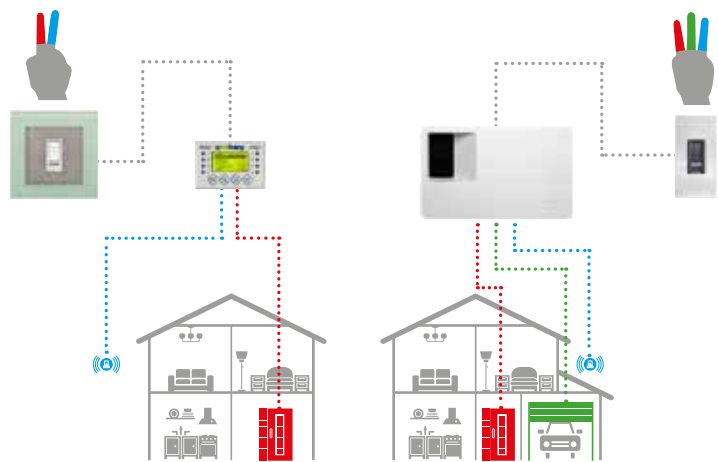

The ideal access solution for home and work.

ekey multi

Multi-point access solutions

4 fingerprint scanners* are managed by a single control panel.

- Can store up to 99 fingers
- Supports up to 4 fingerprint scanners
- Can control up to 4 functions per fingerprint scanner
- Individually programmable time slots
- Access log for every fingerprint scanner
- Easy to operate with central user administration directly via the control panel
- User permissions can be assigned on a personalized basis (based on location and time)
- Vacation or permanent program
- Optional: Transponder access (RFID) is possible -> can also store up to 99 transponders

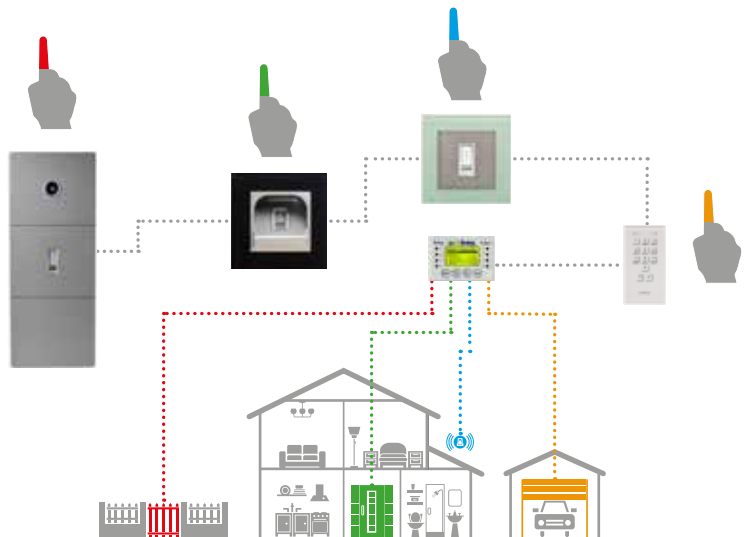

The networkable access solution for companies and discerning households.

ekey net

Network access solutions

The networkable access solution for companies, organizations, and discerning households.

- Can store up to 2,000 fingers per fingerprint scanner*
- Supports up to 80 fingerprint scanners
- Can control up to 4 functions per fingerprint scanner
- Programmable time slots
- Access log for every fingerprint scanner
- Supports cross-site administration
- Central administration via PC
- Calendar function
- Interfaces for establishing external connections
- Optional: Transponder access (RFID) is possible -> can also store up to 2,000 transponders

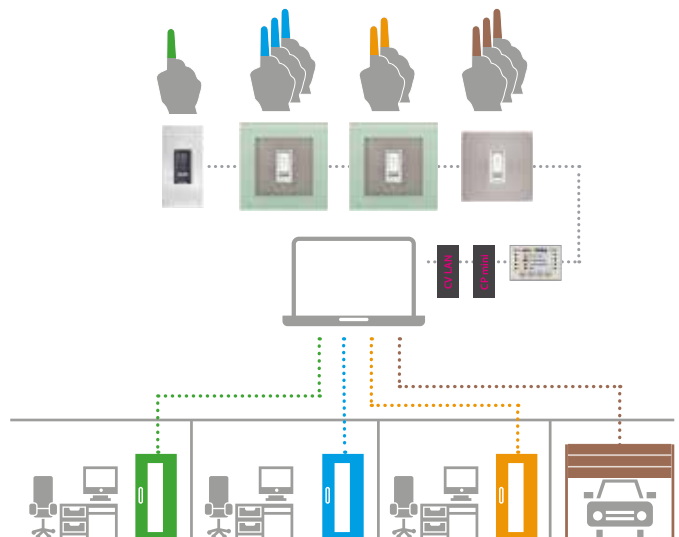

*Alternatively: code pad (keypad) -> can store up to 99 or 2,000 codes



The right model to suit every requirement.

ekey not only develops products, but also solutions that revolutionize entire business sectors. With leading technological expertise, ekey uses the advantages of biometrics to make daily life more convenient for over a million users – and more join them every day!



Wall-mounted

For wall mounting and easy retrofitting.



keypad

The ekey code pad – an alternative to the fingerprint scanner.



Outlet-mounted

For outlet mounting in switch frames or integration into door stations and mailboxes.



integra

For cavity, wall or outlet mounting and integration into doors.

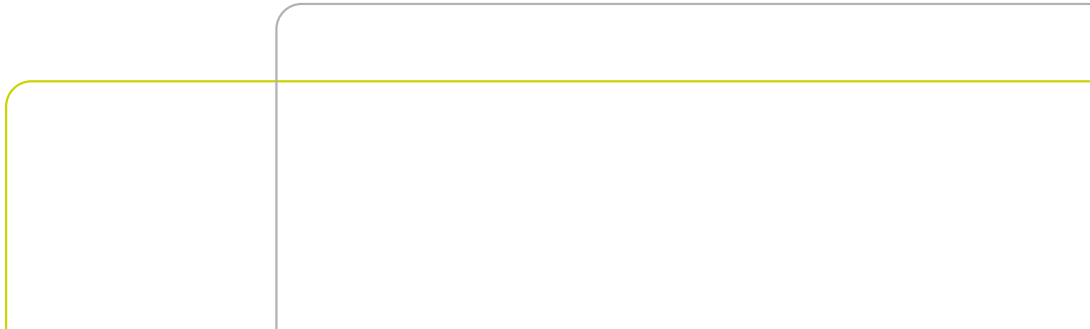



Austria (headquarters)
ekey biometric systems GmbH
Lunzerstraße 89
A-4030 Linz
Phone: +43 732 890 500 2000
office@ekey.net

